

**GAMMA PRODOTTI**

**Sì, siamo proprio noi, France Air Italia!**

E siamo qui, a festeggiare un traguardo importante:

**30 anni**, dal **1994** ad oggi, **2024**.

Una vita, un attimo, un'avventura per realizzare un sogno.

Un anniversario è un'occasione saliente nell'evoluzione di una società.

E' il momento per tracciare un consuntivo di quanto realizzato.

Ma ancor più, per noi, vuol essere un passaggio significativo per rafforzare e confermare i fondamenti su cui poggia il nostro credo.

**Abnegazione:**

nel dare sempre tutto noi stessi, insieme, con dedizione e spirito di condivisione.

**Innovazione:**

nell'interpretare i cambiamenti, nel cercare soluzioni tecniche innovative, nel realizzare progetti eco sostenibili.

**Passione:**

nel compiere il nostro lavoro, nel sostenere i nostri clienti, nel raggiungere, sempre, nuovi obiettivi.

Ringraziamo la famiglia Dolbeau per la fiducia nella famiglia Garolfi.

Ringraziamo Pascal Halimi e tutta la squadra di France Air Francia per il prezioso supporto.

Ringraziamo i nostri collaboratori per il loro impegno e la loro fedeltà.

Ringraziamo clienti e fornitori, a loro dobbiamo ogni successo.

Grazie a tutti!

**Buon Anniversario,  
France Air Italia!**



PRESIDENTE

**France Air**  
ITALIA



## CANALI CIRCOLARI SPIROIDALI

France Air propone canali circolari spiroïdali  
in lamiera zincata con relativi raccordi  
e accessori di montaggio

TRATTIAMO L'ARIA  
PER CREARE BENESSERE



visita il sito: [www.vmc-franceair.com](http://www.vmc-franceair.com)  
contattaci a: [offerte@vmc-franceair.it](mailto:offerte@vmc-franceair.it)

## DIFFUSIONE

### BOCCHETTE E GRIGLIE

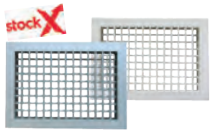

GAC21IT



GPC21IT



SZV21



SAX



GFV  
51/52/61/62IT



GAV51/52



LAC



LAA/LAU



DAV



GLC20AIT



GLC25A



GL30A



GL 20/25 ZFR



GL25 A FR

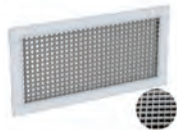

GAQ77

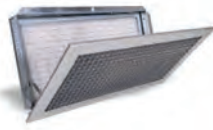

GAQ77ZFR



GAQ77AFR



GAP88/GPP88



GAFP88/GFFP37



GFC37



GAV91



GLF25Z



GTV



GRA



AUSTRALE/BRE-N



BSA/VAUBAN



GLA 50/100 IT



GLF 50/100 IT

## DIFFUSIONE

### DIFFUSORI

stock X



DAV45BSA

stock X



DAV03BSA



DAV45B



DAV03B



DAV 45 P/PS



REACTIL



NEO 2000

stock X



DARP/DARF



DAQP/DAQF



DFWR/DFWS

stock X



GV-MC/GV-MC-Z

stock X



SFWM

stock X



DFWM



DTF



DBP IMPULSE



DBP200

stock X



DAU40/DAP40



DAU



DFP40RC



DPU40



DAP195/DECÓ



DFU 36/37

stock X



LA600IT



LA500



LA400



LA700

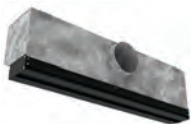

LDH  
NOVITÀ



LDD 30/50  
NOVITÀ

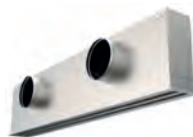

LDM  
NOVITÀ



LDA  
NOVITÀ

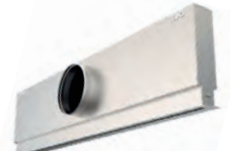

LDF  
NOVITÀ



PERLYS-L

stock X



PERLYS



BMU15



BMU 40



JSD

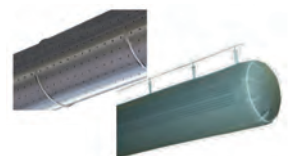

TMF/TEXTIL AIR

## DISTRIBUZIONE

### TUBI FLESSIBILI IN EUROCLASSE Bs1d0



AV25  
NOVITÀ



AV25ISO  
NOVITÀ



PHONIFLEX  
NOVITÀ



COMPRIFLEX  
NOVITÀ



ISOFLEX  
NOVITÀ



ISOFLEX-W  
NOVITÀ



ISOFLEX-H  
NOVITÀ

### SERRANDE



CLDF/T



CPL2



CIR

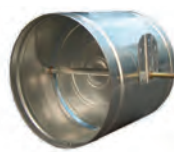

CLD



LDRI50



LDT100E



DLAZ100



DLA150



LDT-T  
NOVITÀ



SPC



SPFA50/100IT



SPK100IT

### COMANDI



COMANDI  
ELETTRICI



COMANDI  
MANUALI

### SEPARATORI DI GOCCE



DP



SP

### GRIGLIA ANTISABBIA

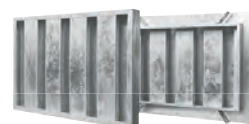

GAZ

## DISTRIBUZIONE

### REGOLATORI - VAV - CAV



### ISOLAMENTO CANALI



### ACCESSORI



## PROTEZIONE INCENDIO

### SERRANDE TAGLIAFUOCO



### VALVOLE E GRIGLIE TAGLIAFUOCO



## VENTILAZIONE

### VENTILATORI CENTRIFUGHI



## VENTILAZIONE

### VENTILATORI ELICOIDALI ECM



HELIPAC 3  
NOVITÀ



HELIPAC 3 ECM



MODULYS ECM



EVOLYS



ENERGY  
SILENCE



ENERGY  
SILENCE DESIGN



ENERGY  
SILENCE EVO



ENERGY SILENCE  
COMPACT



TUBO



ENERGY  
500/900/1800



ICON

### ESTRATTORI

## FILTRAZIONE

### FILTRINE SINTETICHE

### FILTRI PIANI



FAG 200



FR MEDIA



FR PS2

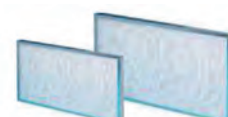

FR PS3



FR PS4

### FILTRI ONDULATI

### FILTRI A TASCHE MORBIDE

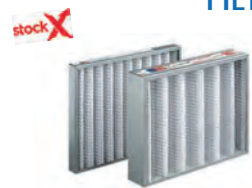

FR OS4



FR OS5

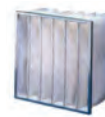

FR BAG



FR TFSZ

### FILTRI A TASCHE RIGIDE

### FILTRI ASSOLUTI



FRV



FR VB



FR VE



FR MPL H14

### FILTRI ALTA EFFICIENZA

### CASSONI FILTRANTI



FR MPP

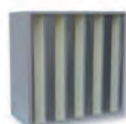

FR MPM



CPF C



CASSONE L, XL e XXL



## ACUSTICA

### SETTIACUSTICI

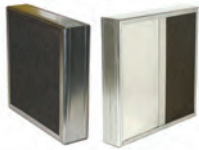

SRB-ARPEGE - SRB-OCTAVE

### SILENZIATORI RETTANGOLARI

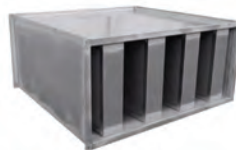

SRC-ARPEGE - SRC-OCTAVE



VDI 6022

### SILENZIATORI CILINDRICI



SC / SCN



SC VMC



TM25



VDI 6022

### GRIGLIE AFONICHE



ATSON



VDI 6022

### SILENZIATORI MODULARI



ALVEO

## ESTRAZIONE FUMI

### SERRANDE EVACUAZIONE FUMI

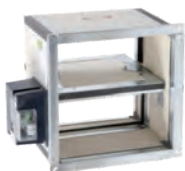

REF VD3



FSD  
NOVITÀ



FDSD  
NOVITÀ

### TORRINO



SIMOUN  
SIMOUN ECM

### VENTILATORE CASSONATO



DÉFUMAIR/  
DÉFUMAIR ECM

### VENTILATORE ASSIALE



AXALU F400  
AXALU BOX

## RISCALDAMENTO

### BATTERIE DI RISCALDAMENTO



SYSTAIR EC  
NOVITÀ

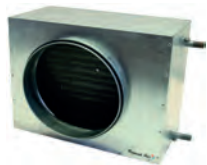

SYSTAIR EF ISOLATA  
NOVITÀ



CIREC 2/CIREC 2A



SYSTAIR IT



KT-EH

### UMIDIFICATORI

## CUCINE

### CAPPE PROFESSIONALI

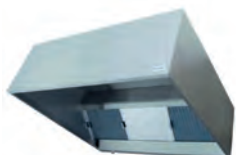

ATRIA/MOOREA  
STATICA



ATRIA/MOOREA  
COMPENSATA



ATRIA/MOOREA  
ISOLA  
NOVITÀ



ATRIA/MOOREA PULSE  
INDUZIONE COMPENSAZIONE  
NOVITÀ



MAIA LAVAIR  
LAVASTOVIGLIE

### RECUPERATORI PER CUCINE PROFESSIONALI

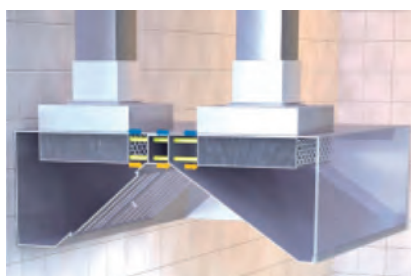

ACTINIS  
(RECUPERO A BATTERIE)



KOOX  
(RECUPERO FLUSSI INCROCIATI)



VERTIGO 2  
(RECUPERO ARIA/ACQUA)

### FILTRAZIONE E DEODORIZZAZIONE



ODORYS 2



OLFACARB 2

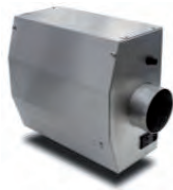

ODOR LIGHT 2



IMMISSORE

### VENTILAZIONE



ESTRATTORI

## IGIENE OSPEDALIERA

### PLAFONI SALE OPERATORIE



BIOVAX 3



WINDHOP 3

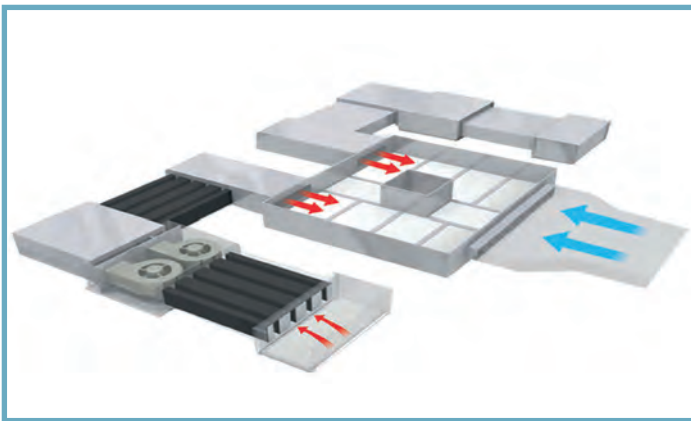

CYCLOPE



CASSIOPEE

### TERMINALI ALTA EFFICIENZA



CPF  
NOVITÀ



DIFFUSE BOX



BVX 3 SLIM



GFFSP/GTR20



CANISTER  
NOVITÀ



MODULAC

## SANIFICAZIONE

### PLASMA FREDDO



KALISSIA® AIR



PLASMAIR  
NOVITÀ



UVC-AIR

### EMETTITORE DI IONI NEGATIVI



SANIONI

### OZONIZZATORE



OZONIZZO

## LAME D'ARIA

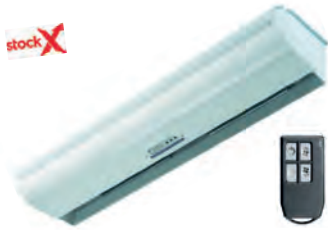

HARMONY ONE EVO



HARMONY SLIM



HARMONY SIGHT



HARMONY FINESSE ECM  
**NOVITÀ**



HARMONY VERTICAL



INDUSSY 2

## RECUPERATORI DI CALORE

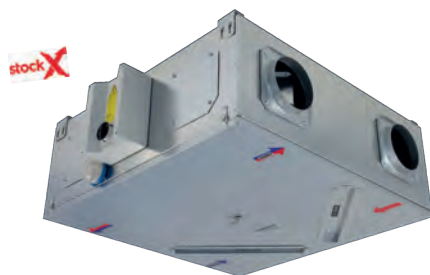

RECEPTO H



RECEPTO V



RECEPTO PLUS H/V



REFRIGERIUM PLUS EC



RINNOVO H



RINNOVO V  
**NOVITÀ**



ACTIVE SCHOOL H



ACTIVE SCHOOL V  
**NOVITÀ**



ACCESSORI

**VMC - VENTILAZIONE MECCANICA CONTROLLATA**



RECUPERATORI PUNTUALI  
**NOVITÀ**



COCOON DOMO SMALL Z



COCOON DOMO PLUS H/V



EVOLVO TER SMALL H/V



EVOLVO TER H/V



EVOLVO TER PLUS H/V



DEUMIDIFICO PLUS H/V  
**NOVITÀ**

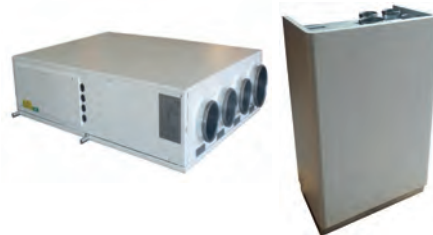

SALUS DUE H/V

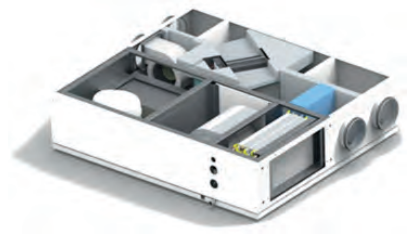

SALUS 3+2



SINTESI H/V



REFRIGERIUM DOMO

**INVERTER**



SPLENDIDO  
**NOVITÀ**



CONDOTTI/RACCORDI



CONNETTORI E PLENUM



TERMINALI E VALVOLE

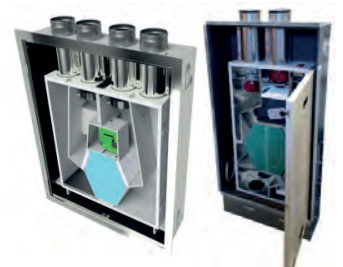

VMC AD INCASSO

## PROGETTAZIONE

France Air Italia avvalendosi di collaboratori con una esperienza ventennale nel settore della climatizzazione dell'aria, progetta diffusori tessili, metallici e plastici per la diffusione dell'aria nel settore industriale e civile ad alto contenuto tecnologico. Grazie a soluzioni efficienti, proponiamo sistemi innovativi appositamente studiati per la distribuzione dell'aria in piccoli

e grandi ambienti rendendo i prodotti idonei per tutte le tipologie d'impiego (ventilazione, condizionamento, riscaldamento e raffrescamento) per uffici, locali commerciali e industriali, fiere, piscine, biblioteche e centri commerciali. Il nostro ufficio tecnico è a disposizione dei clienti per aiutarli ad identificare soluzioni tecniche specifiche per ogni singola esigenza.



SOFTWARE

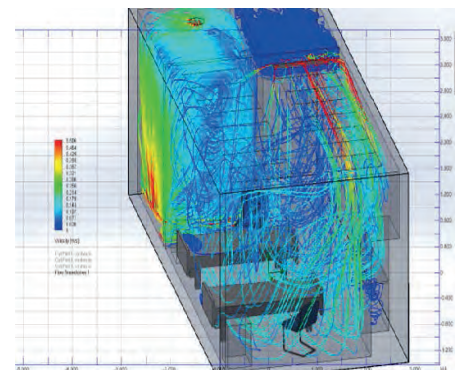
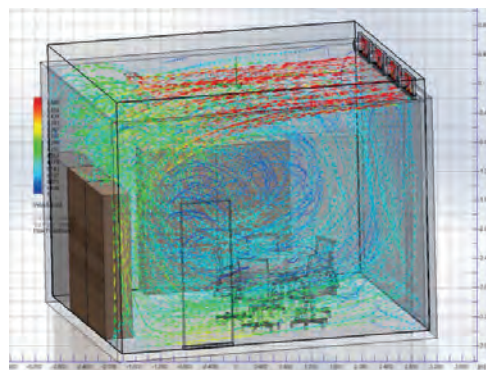
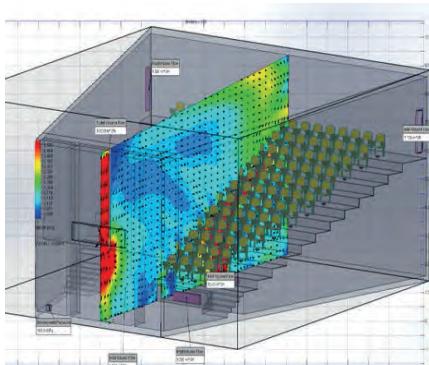
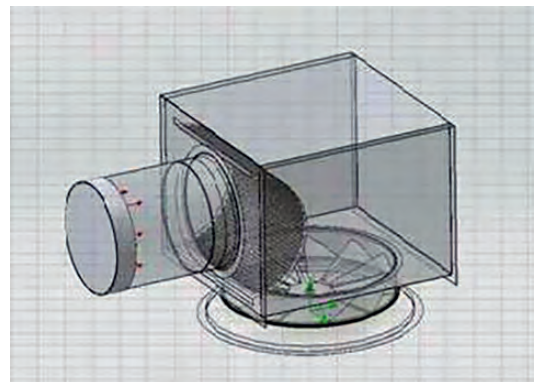
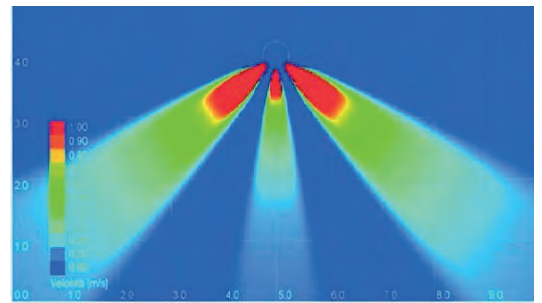
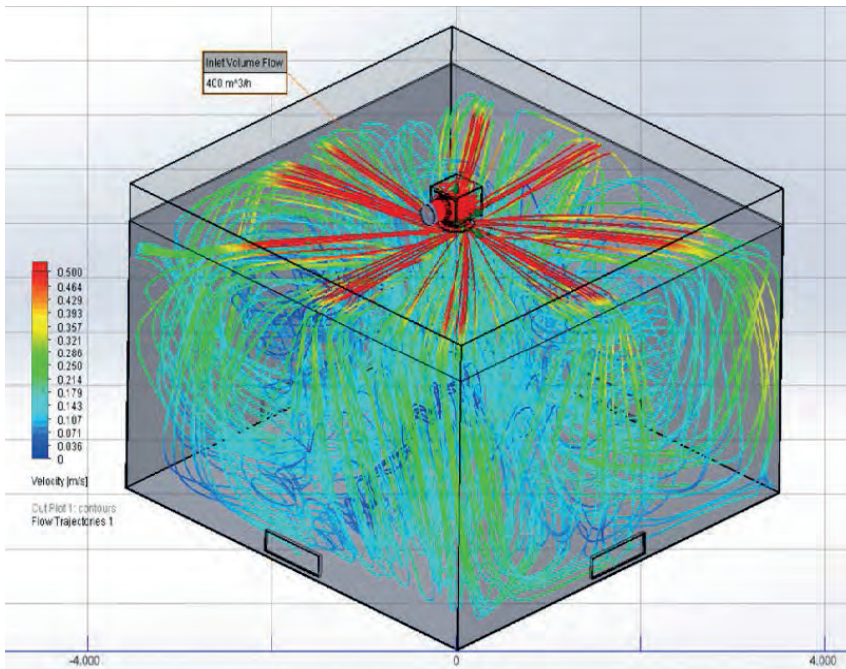

# France Air

## ITALIA



FGA AEROTERMICA ITALIANA



**GAMMA PRODOTTI**



**CATALISTINO**



**LAME D'ARIA**



**RECUPERATORI**



**VMC**

**France Air Italia S.r.l.**  
Via Marconato, 19/B  
20811, Cesano Maderno (MB) Italy  
[www.vmc-franceair.com](http://www.vmc-franceair.com)  
Tel. +39 (0) 3621867800 R.A.

**Ufficio Commerciale:** [offerte@vmc-franceair.it](mailto:offerte@vmc-franceair.it)  
**Ufficio Tecnico:** [tecnico@vmc-franceair.it](mailto:tecnico@vmc-franceair.it)  
**Ufficio Ordini:** [ordini@vmc-franceair.it](mailto:ordini@vmc-franceair.it)  
**Ufficio Spedizioni:** [logistica@vmc-franceair.it](mailto:logistica@vmc-franceair.it)  
**Ufficio Amministrazione:** [amministrazione@vmc-franceair.it](mailto:amministrazione@vmc-franceair.it)

